

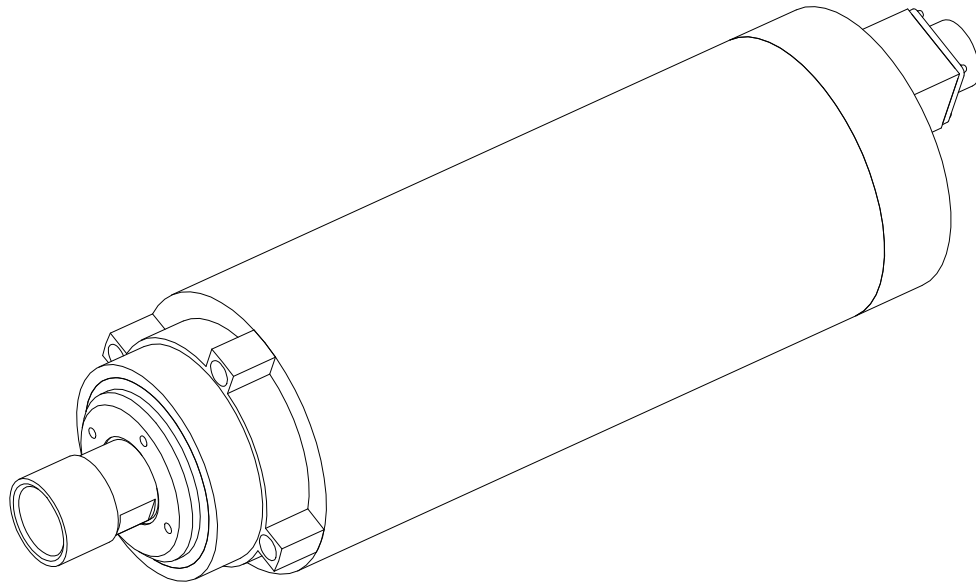

STF80-2.2-ER20

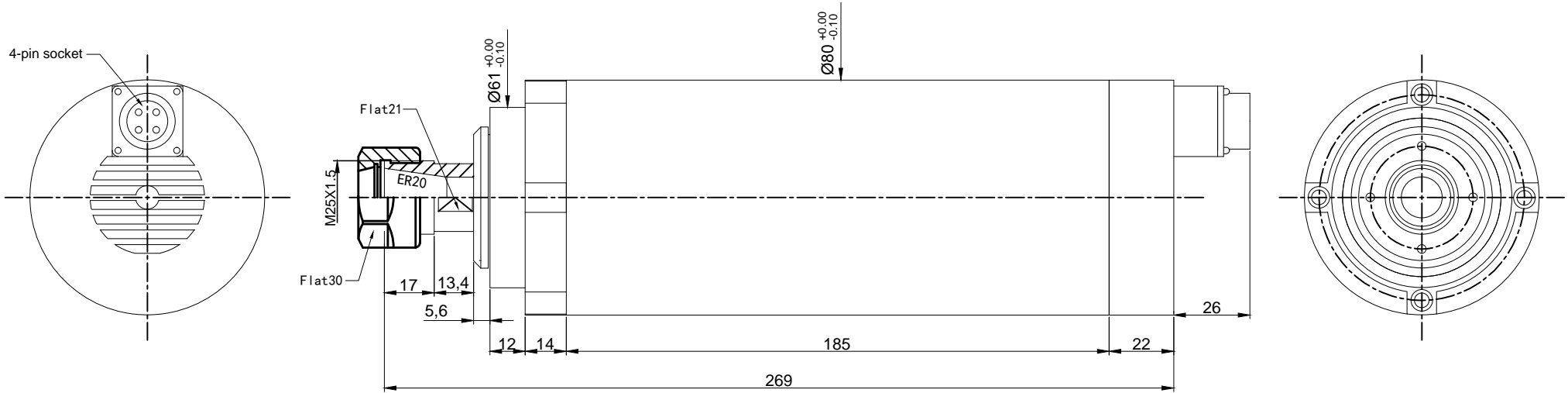

Wiring description

Pin	4-pin socket
1	U frequency converter phase
2	V frequency converter phase
3	W frequency converter phase
4	Wring ground 

【CAUTION】

Rotating mode: anticlockwise from the shaft extension end

WHD SPINDLE MOTOR

Power	Voltage	Current	Shaft	Frequency	Speed	Cool	Weight
2.2KW	220V	8.0A	ER20	400Hz	24000RPM	Air	4.8KG