

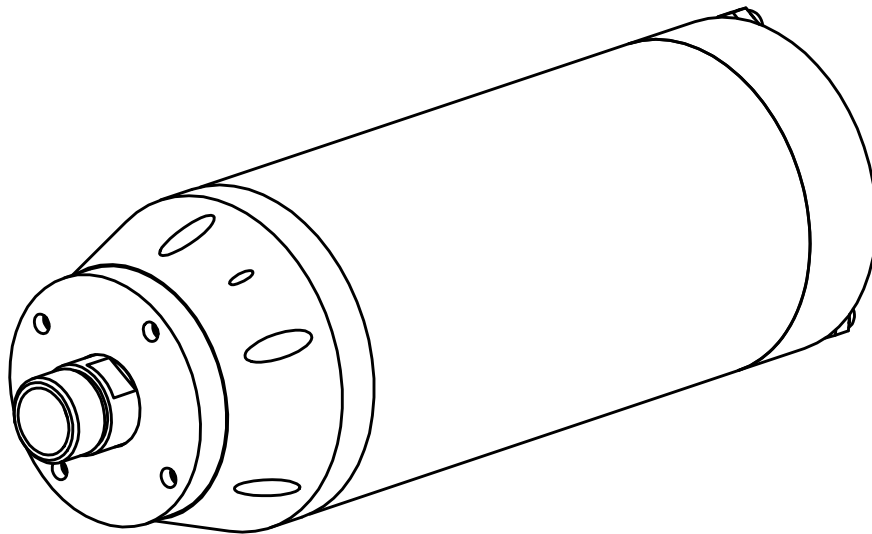

STZ125-6.0Z-ER25

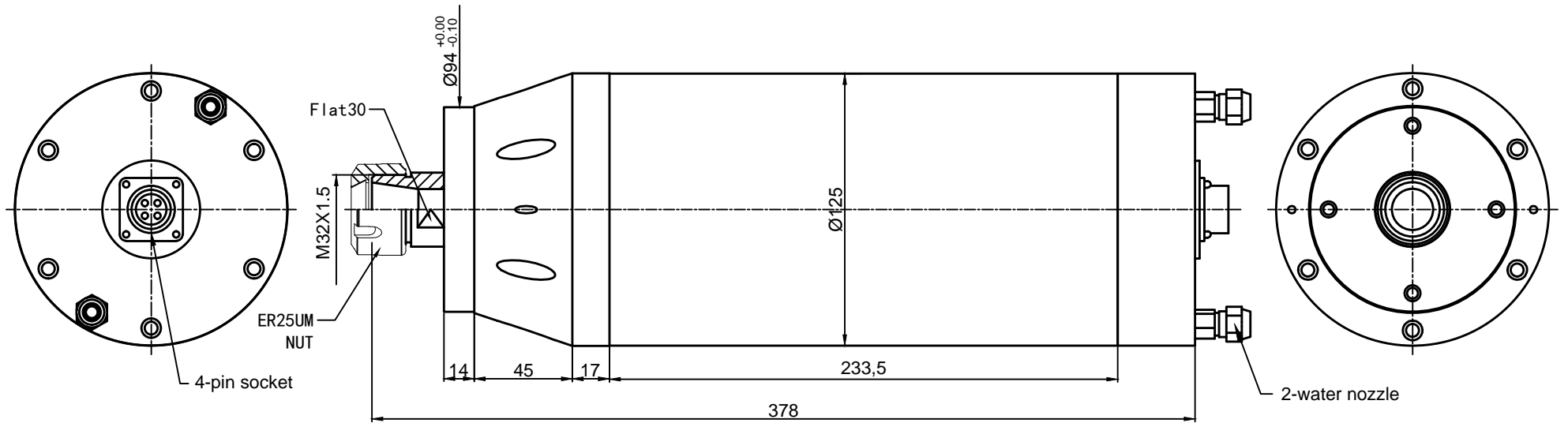

Wiring description

Pin	4-pin socket
1	U frequency converter phase
2	V frequency converter phase
3	W frequency converter phase
4	Wring ground 

【CAUTION】

Rotating mode: anticlockwise from the shaft extension end

WHD SPINDLE MOTOR

Power	Voltage	Current	Shaft	Frequency	Speed	Cool	Weight
6.0KW	380V	14.5A	ER25	400Hz	24000RPM	Water	23.4KG